

Design Shoichi Uchiyama

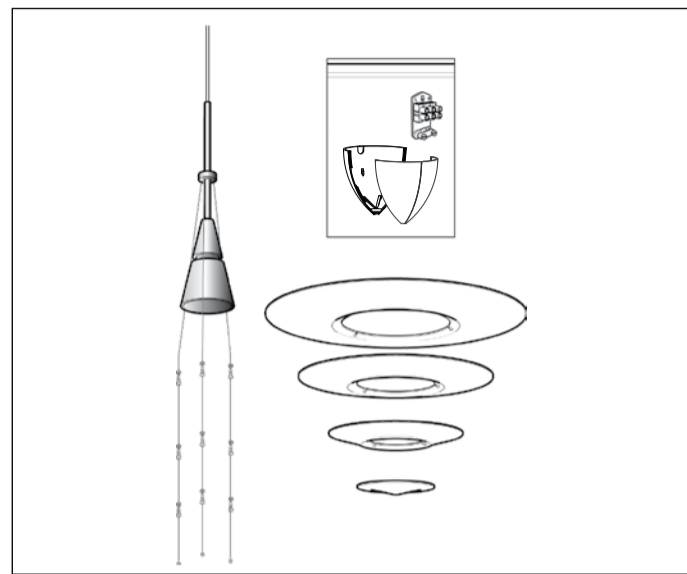
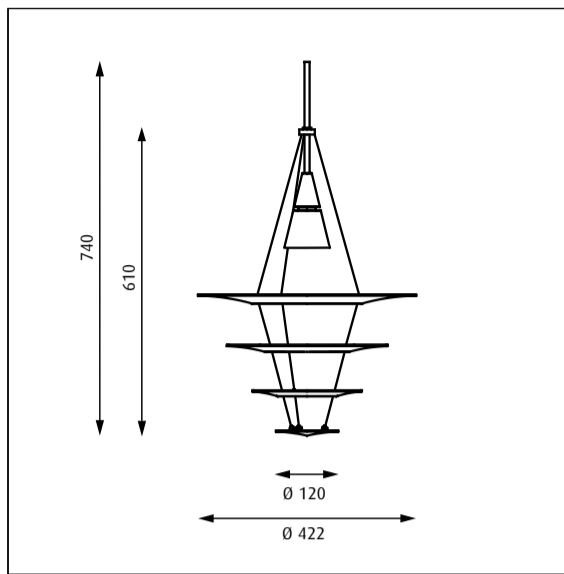

117270-11

Lyskilde Light source Leuchtmittel Ljuskälla Sorgenti luminose Source lumineuse Fuente de luz Valonlähde	Spænding/frekvens Voltage/frequency Spannung/frequenz Spänning/frekvens Tensione/frequenza Voltage/frequence Tensión/frecuencia Jännite/taajuus	Vægt Weight Gewicht Vikt Peso/ingombro Poids Peso Paino	Isolationsklasse Electric shock protection Schutzklasse Schutzklasse Isolationsklass Classe di isolamento Protection au choc électrique Clase de aislamiento Eristysluokka	Tætheddsklasse Ingress protection Schutzart Schutzart Kapslingsklass Grado di protezione Indice de protection Clase de protección Kotelointiluokka
1x50W QR GU 10	Max 230V/50Hz	1,0 kg	Cl. II	IP 20

DA

Støv aftørres med en tør, blød klud. Fedtpletter og lignende kan fjernes med en blød klud opvredet i lunkent vand (<50° C) tilsat mildt rengøringsmiddel.

Brug aldrig rengøringsmidler med slibemiddel eller opløsningsmidler.

EN

Wipe off dust with a dry, soft cloth. Remove greasy spots etc. with a soft cloth dampened in lukewarm water (<50° C) with a mild detergent.

Never use detergents containing abrasives and solvents.

DE

Staub bitte mit einem trockenen, weichen Lappen abwischen. Fettflecke und dgl. mit einem feuchten, in lauwarmem Wasser (<50° C) mit mildem Reinigungsmittel ausgewaschenen Lappen entfernen.

Niemals Reinigungsmittel mit Schleifmittel oder Lösungsmittel verwenden.

SV

Lampan dammtorkas med en torr, mjuk trasa. Fettfläckar tas bort med ljummet vatten (<50° C) utblandat med mildt rengöringsmedel.

Använd aldrig rengöringsmedel som innehåller slipmedel eller lösningsmedel

IT

Pulire la polvere esterna con un panno morbido e asciutto. Rimuovere macchie di grasso ecc. con un panno morbido inumidito in acqua tiepida (<50° C) e con un detergente leggero.

Non usare mai detergenti contenenti abrasivi o solventi.

FR

Essuyez la poussière avec un chiffon sec et doux. Enlevez les points de saleté etc. avec un chiffon doux imprégné d'eau claire tiède et de détergent doux.

Ne jamais utiliser de détergents contenant des abrasifs et des solvants.

ES

Limpiar con paño seco y suave. Quitar manchas de grasa y otras con paño suave humedecido con agua templada (<50° C) con detergente poco agresivo.

Nunca use detergentes que contengan abrasivos y disolventes.



FI

Pyyhi pölyt kuivalla pehmeällä liinalla. Poista rasvatahrat miedolla pesuaineella ja haalealla vedellä (<50° C) kostutetulla pehmeällä liinalla.

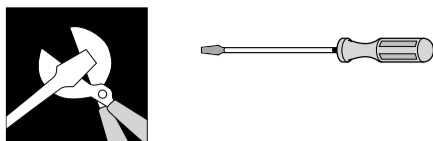
Älä koskaan käytä liuottimia tai hankausaineita sisältäviä pesuaineita.

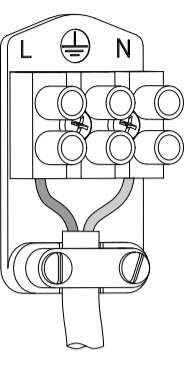
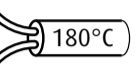

	L	N
DA	Brun	Blå
SV	Brun	Blå
EN	Brown	Blue
DE	Braun	Blau
IT	Marrone	Blu
FR	Brun	Bleu
ES	Marrón	Azul
FI	Ruskea	Sininen

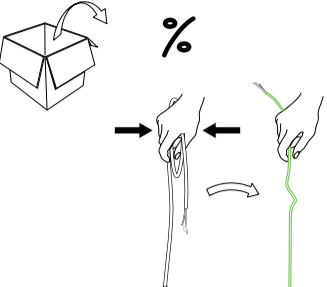
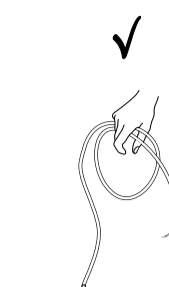
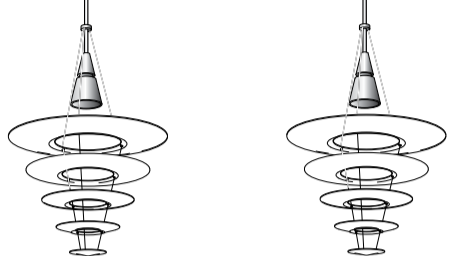

ID NUMBER: _____

Please register ID number at www.louispoulsen.com

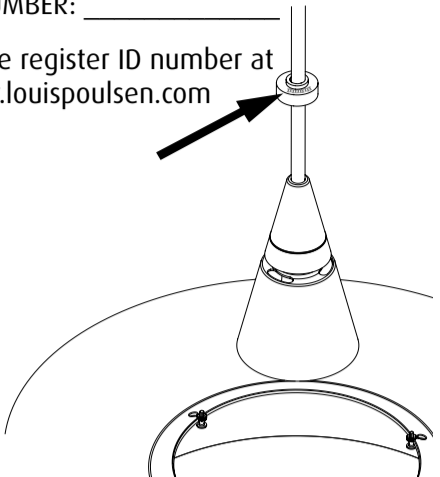

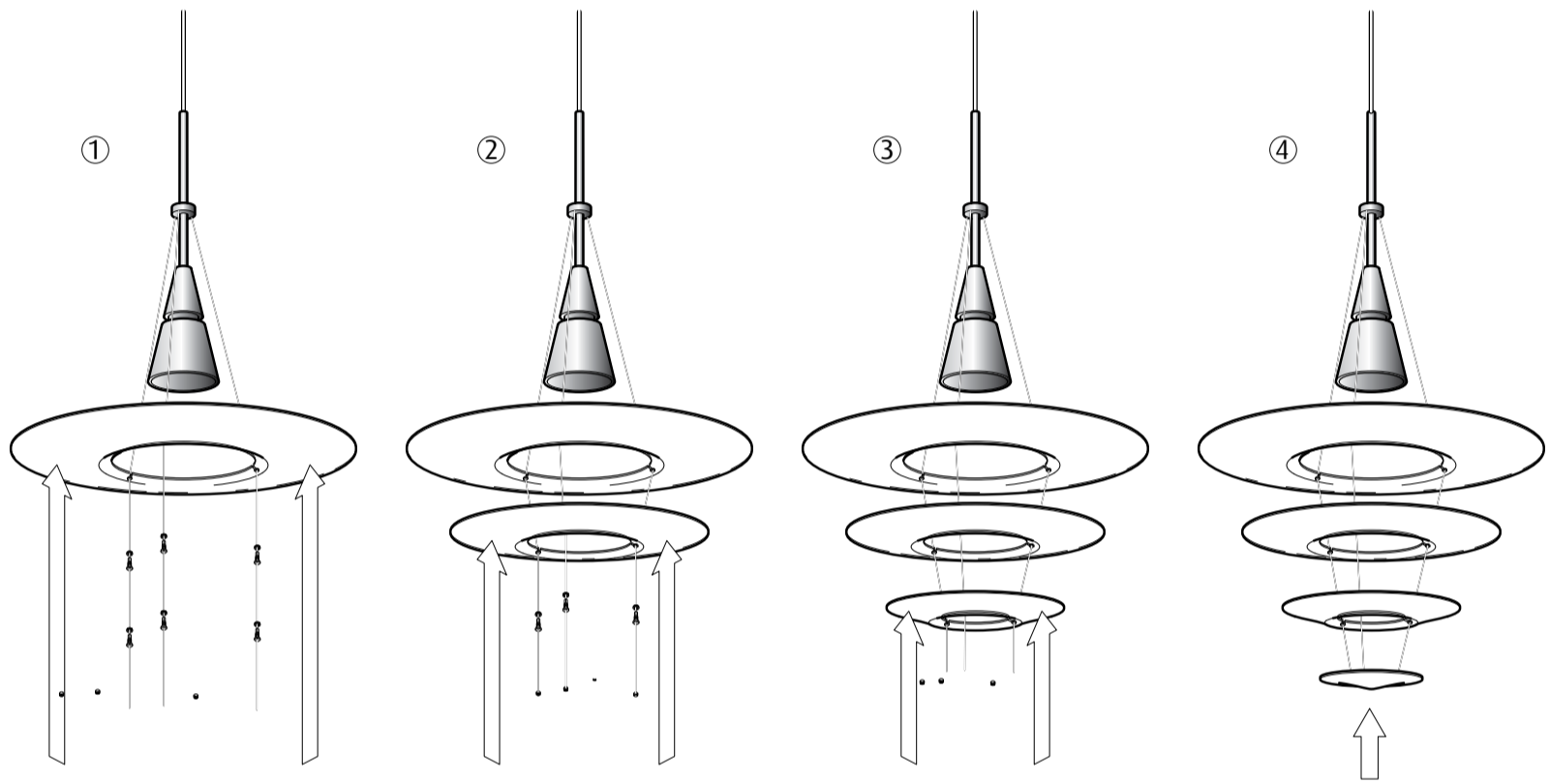

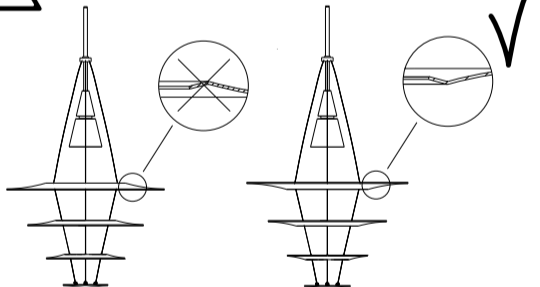
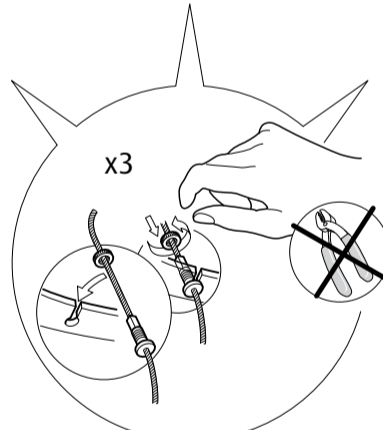
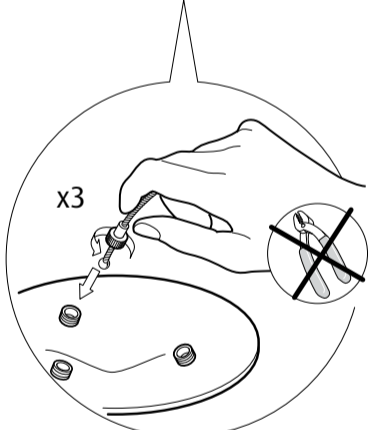
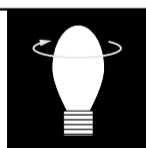
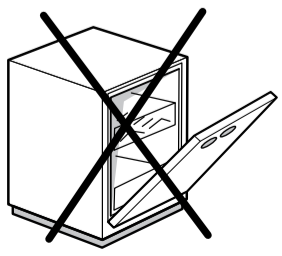
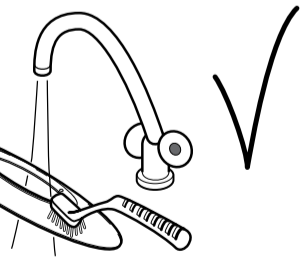
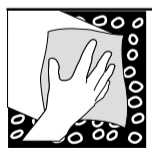
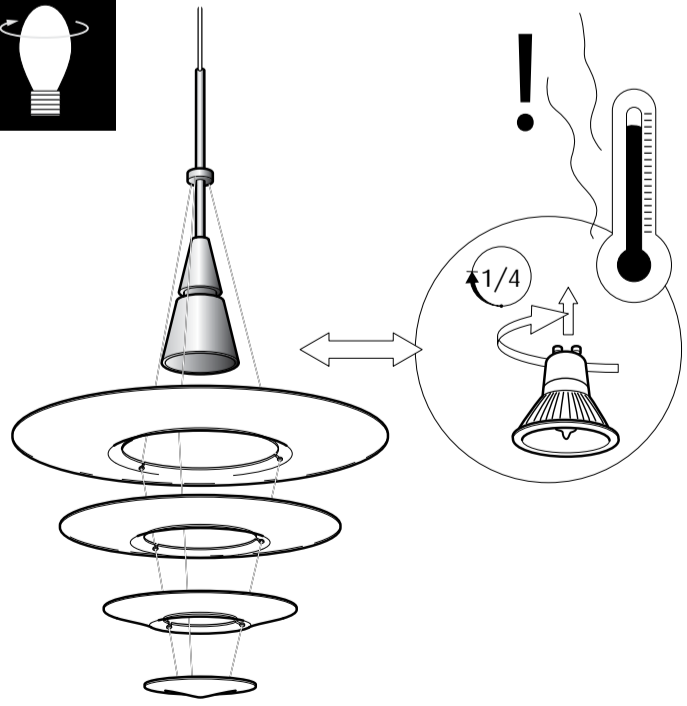
- ①
- ②
- ③
- ④

GU10
230-240V



"Q-PAR"
"TWISTLINE"
"HALOPAR16"
"MR16"

